

Bulldog bookmark

Designed by: Christine Edison

Diagrams by: Himanshu Agrawal

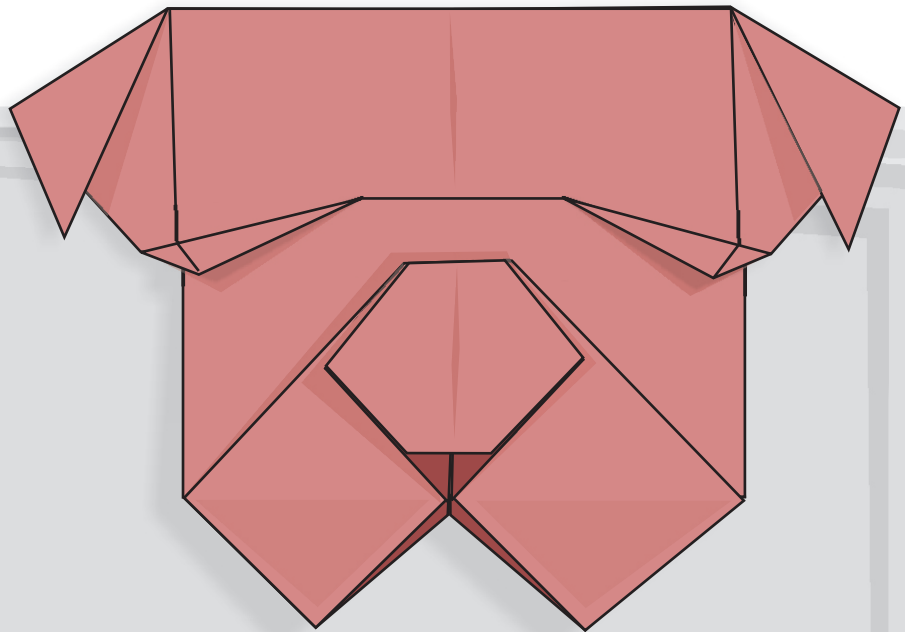

Bulldog bookmark

Designed by Christine Edison
Diagrams by Himanshu Agrawal

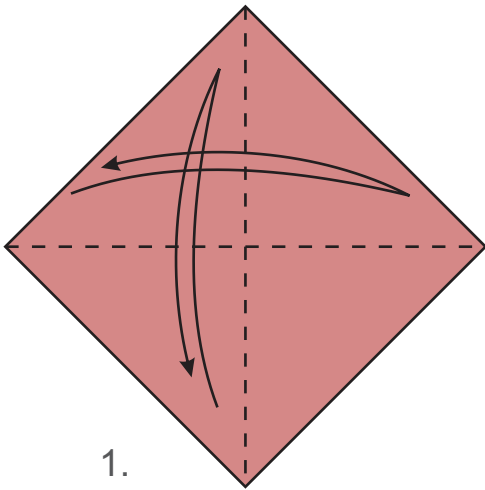

1.
Fold and unfold.

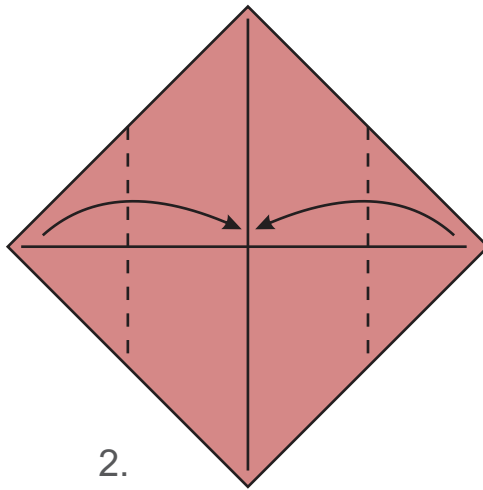

2.

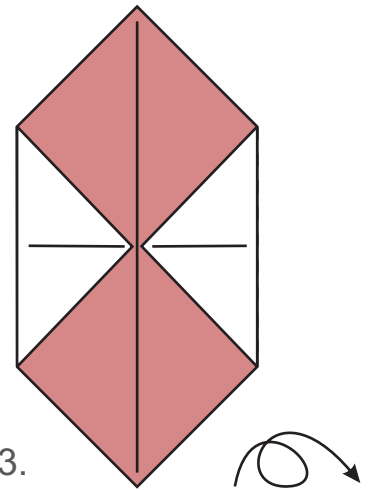

3.

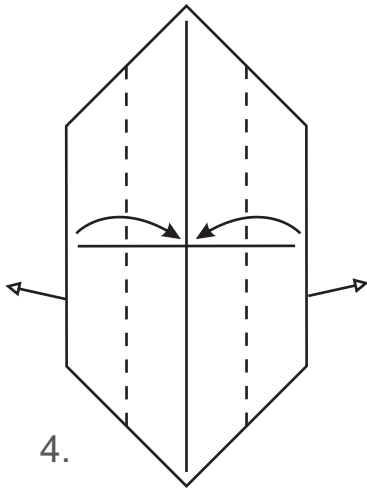

4.
Allow the corners to flip-out.

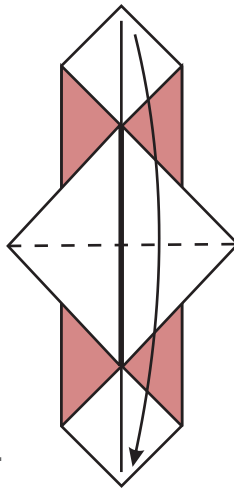

5.

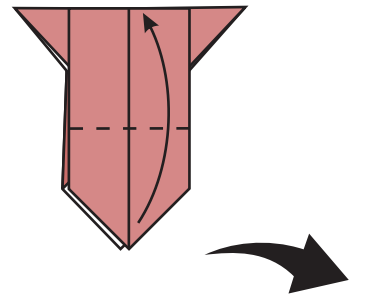

6.

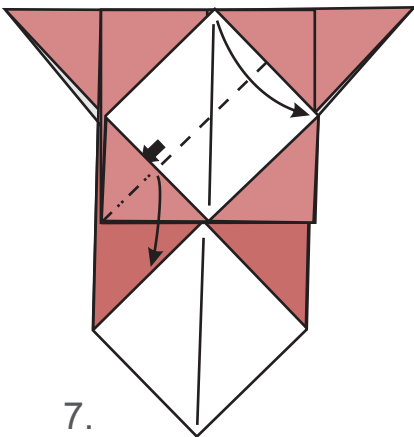

7.
Squash-fold.

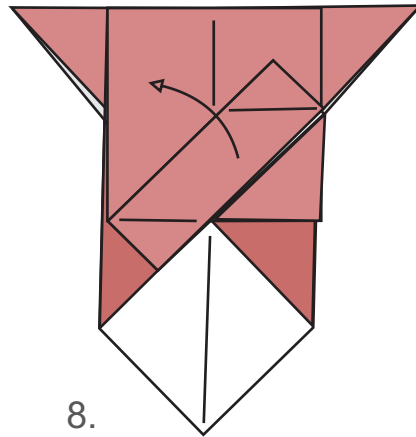

8.
Unfold to 7.

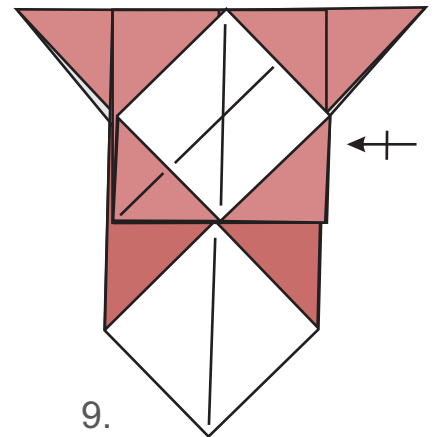

9.
Repeat 7 & 8 on
the other side.

Bulldog bookmark (cont.)

Designed by Christine Edison
Diagrams by Himanshu Agrawal

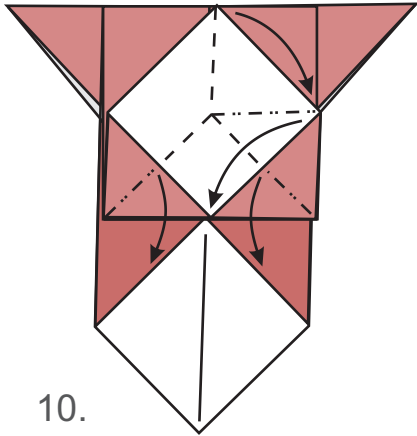

10.
Refold along
the creases.

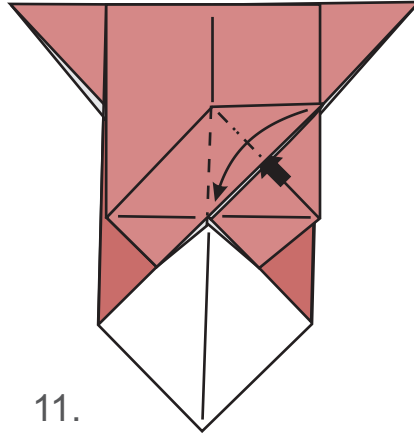

11.
Squash-fold.

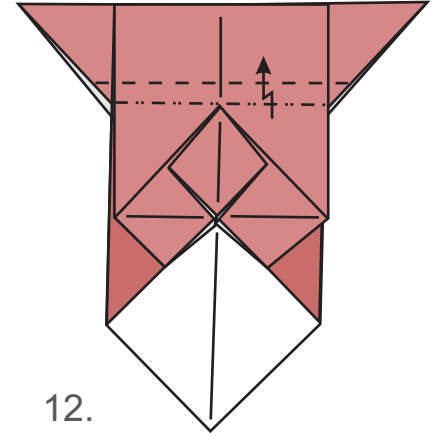

12.
Pleat-fold the top layer
to mark the forehead.

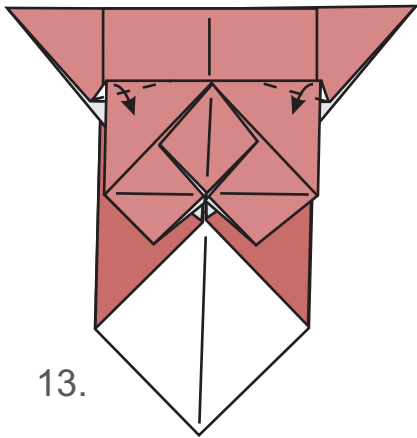

13.

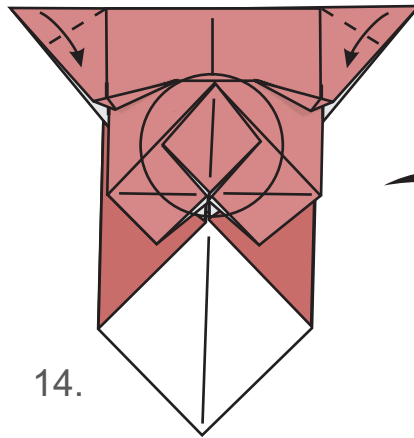

14.

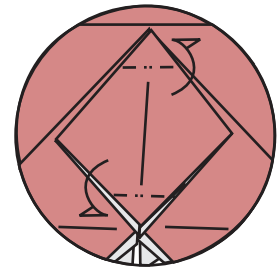

15.
Shape the nose with
mountain-folds.

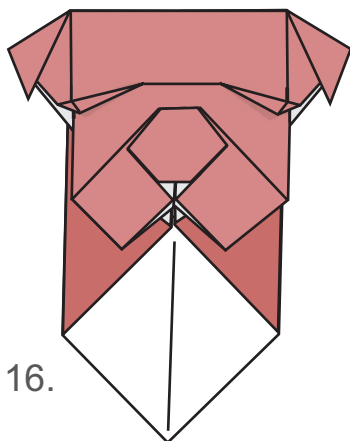

16.
Complete.

